

SPICE thermal model

PSMN1R2-25YLD

Symbol	Parameter	Conditions	Min	Typ	Max	Unit
$R_{th(j-mb)}$	thermal resistance from junction to mounting base		-	-	0.87	K/W

C_{th1}	3.687E-04 F
C_{th2}	1.707E-04 F
C_{th3}	5.386E-04 F
C_{th4}	2.403E-03 F
C_{th5}	6.038E-03 F
C_{th6}	1.368E-02 F
C_{th7}	2.878E-01 F
R_{th1}	3.468E-04 Ω
R_{th2}	6.844E-03 Ω
R_{th3}	1.744E-02 Ω
R_{th4}	4.403E-02 Ω
R_{th5}	1.848E-01 Ω
R_{th6}	5.708E-01 Ω
R_{th7}	4.575E-02 Ω

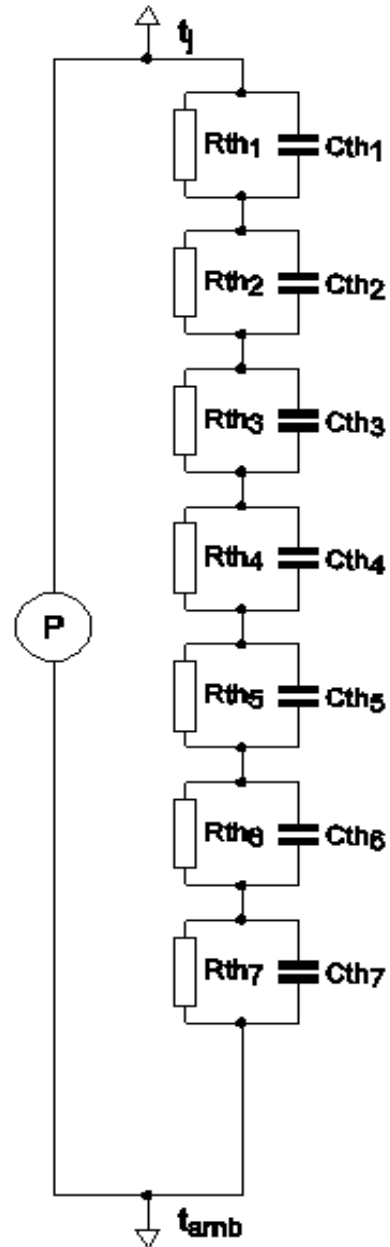

Part: PSMN1R2-25YLD
 Date: 17/3/2016
 Model Rth 0.87 K/W